

Vroom18 Cabinet Installation

1. Before installing, remove bracket from the bottom of the Vroom by inserting a flat blade screwdriver into the release tabs located on each side of the mounting bracket as shown.

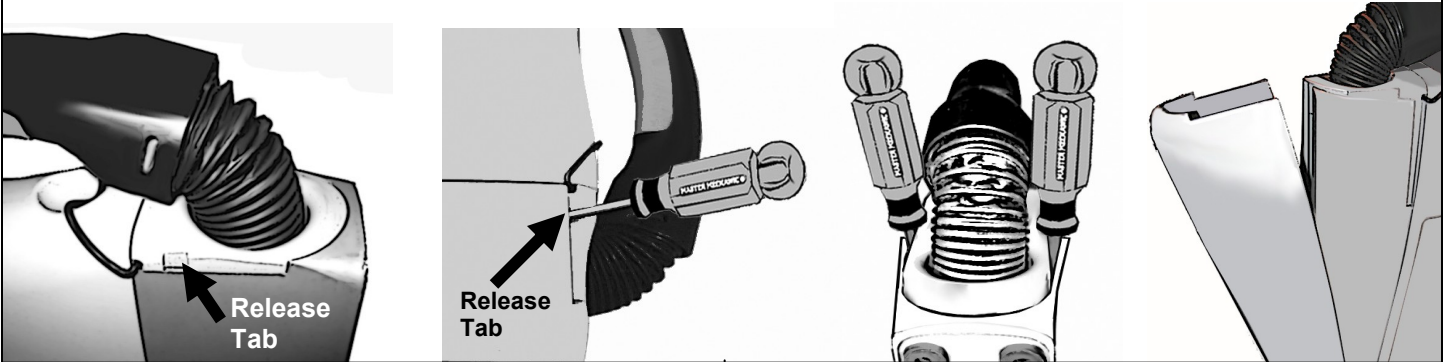

2. Locate cardboard Template inside the cabinet.

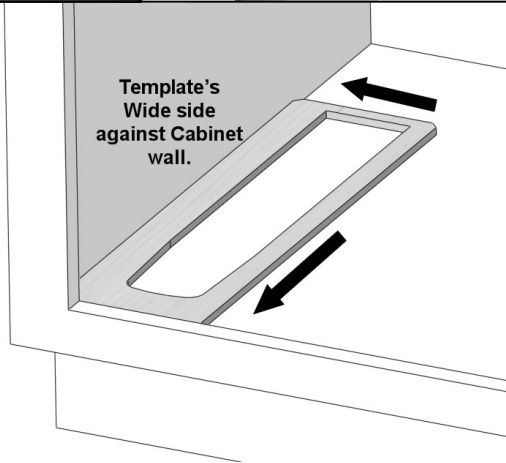

3. Place mounting bracket in template.

Secure with 5 screws as shown.

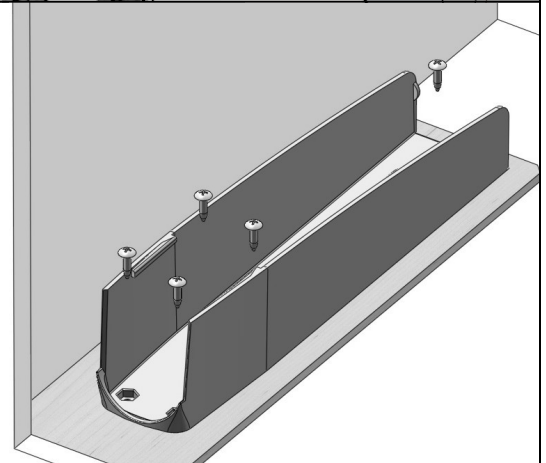

4. Remove the cardboard template.

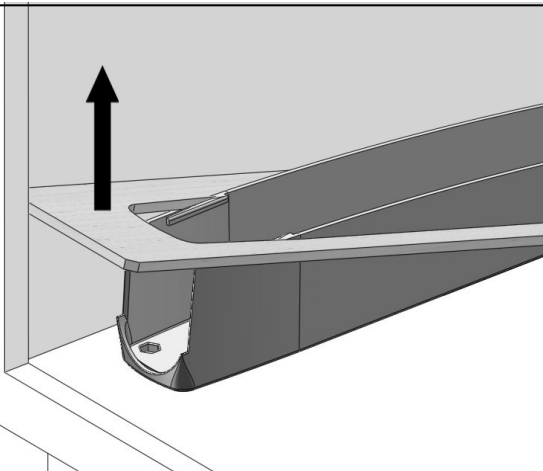

5. Install the Vroom in the mounting bracket by pushing it into place as shown. It will snap in place when installed correctly.

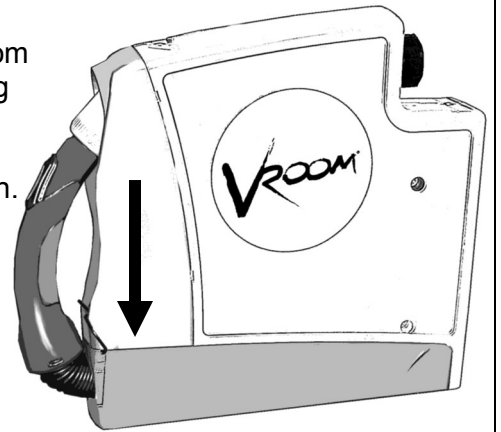

6. Connect the vacuum tubing to the Vroom's connector on the back as shown. Do NOT glue, press fit only.

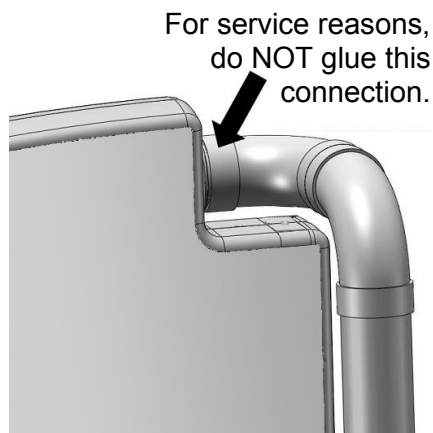

7. Connect the low voltage wires on the back of the unit.

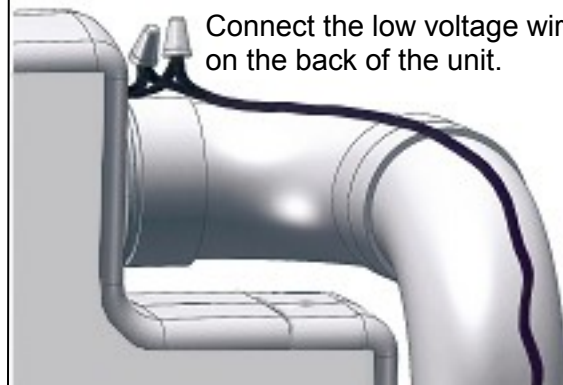

Using Your New Vroom18

INCLUDED:

- ① Vroom
- ② Vroom Base
- ③ Installation Components and Hardware (not shown)



4. Optional Accessory Usage

Slip tool or wand securely onto end of hose handle.

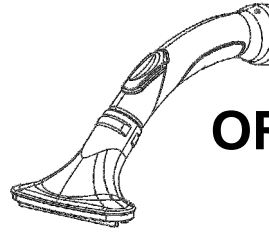

OR

Push wand button to adjust wand length.

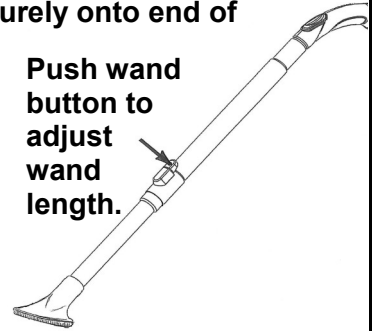

1. Turn It On

Just lift the handle until the Vroom clicks on.

Then pull out the handle.

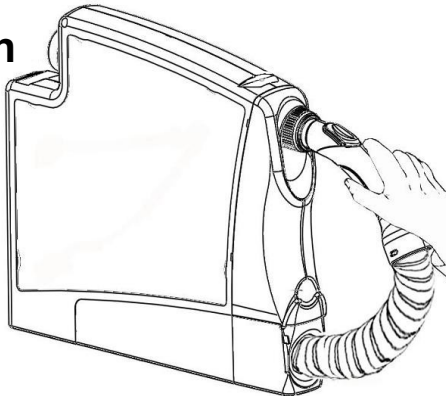

5. When Finished

Flip up the hose lock when finished.

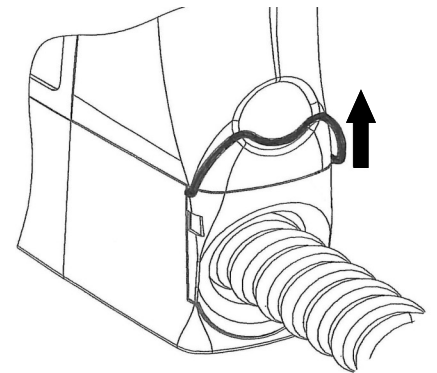

2. Lock the Hose

Pull out as much hose as you want.

Then flip the Hose Lock down (as shown) to hold it in place.

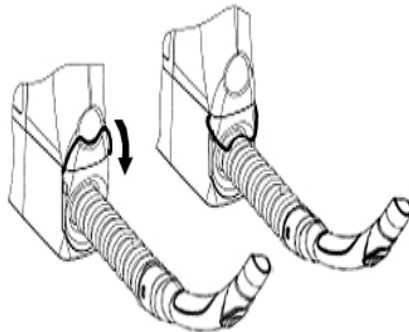

6. Retract the Hose

Cover the handle end with your hand.

The Vroom hose retracts automatically.

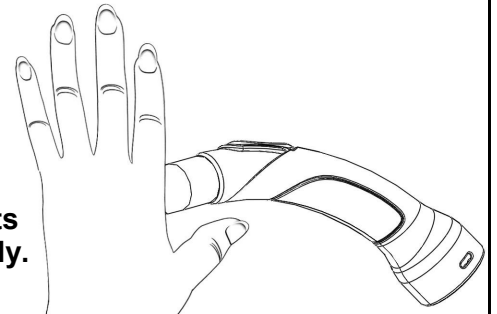

3. Vacuum with the Handle

The rounded edge of the handle means you can vacuum without an attachment.

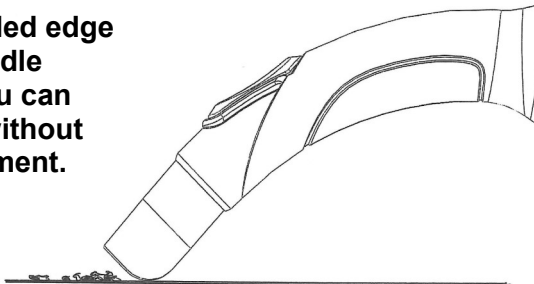

7. Store the Handle

Place the Handle inside the green knob and lower it into the storage position as shown. Vroom turns off automatically.

